

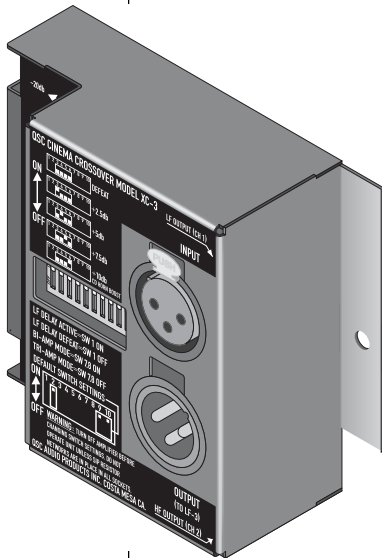

Cinema Accessories

for DCA Series amplifiers

USER MANUAL



▼ **XC-3**

Two-way crossover with delay

▼ **LF-3**

Low-frequency filter with delay

▼ **SF-3**

Subwoofer filter



IMPORTANT SAFETY INFORMATION: PLEASE REVIEW!

EXPLANATION OF GRAPHICAL SYMBOLS



The lightning flash with arrowhead symbol, within an equilateral triangle, is intended to alert the user to the presence of uninsulated “dangerous voltage” within the product’s enclosure that may be of sufficient magnitude to constitute a risk of electric shock to humans.



The exclamation point within an equilateral triangle is intended to alert the users to the presence of important operating and maintenance (servicing) instructions in the literature accompanying the product.

SAFEGUARDS

Electrical energy can perform many useful functions. This unit has been engineered and manufactured to assure your personal safety. Improper use can result in potential electrical shock or fire hazards. In order to not defeat the safeguards, observe the following instructions for its installation, use and servicing.

- Maximum operating ambient temperature is 50° C.
- When installing equipment into a rack, distribute the units evenly. Uneven weight distribution can be hazardous.
- Connect the unit only to a QSC DCA, CX, or PL2 Series amplifier.
- Maintain reliable earthing (grounding) of all rack-mounted equipment.



CAUTION: To reduce the risk of electric shock, do not remove the cover. No user-serviceable parts inside. Refer servicing to qualified service personnel.

WARNING: To prevent fire or electric shock, do not expose this equipment to rain or moisture.

WARNING!

While QSC has endeavored to develop and produce the most dependable and robust Cinema Accessory for your use, QSC cannot be held responsible for damages resulting from any deviation or failure by the user to strictly follow the recommendations set forth in the user manual.

All risks attendant to integration of user-configurable Cinema Accessories with your sound system are assumed by you. While QSC strives to supply the highest quality technical solutions, in no event will QSC or its suppliers be held liable for any damages, consequential, incidental, or otherwise, including any claims for lost profits and/or savings resulting from any attempted integration of the cinema accessories which does not strictly adhere to the manual’s recommendations.

©Copyright 1998, 2002 QSC Audio Products, Inc. All rights reserved.

“QSC,” “DCA,” “DataPort,” and the QSC logo are registered trademarks of QSC Audio Products, Inc.

TABLE OF CONTENTS

INTRODUCTION

Introduction and description of each model.....4

CONFIGURING THE ACCESSORIES

General configuration information, all models.....5

XC-3

Setting up the XC-3.....6

Factory-installed SIPs.....6

Factory-switch settings.....7

Recommended amplifier settings.....7

Illustrations: Setup flow chart, XC-3 front and rear, delay and crossover SIP selection charts, SIP identifier chart, and HF boost response curve.

LF-3

Setting up the LF-3.....8

Factory-installed SIPs.....9

Factory switch settings.....9

Recommended amplifier settings.....9

Illustrations: Setup flow chart, LF-3 front and rear, delay and crossover SIP selection charts, SIP identifier chart.

SF-3

Setting up the SF-3.....10

Factory-installed SIPs.....11

Factory switch settings.....11

Recommended amplifier settings.....11

Illustrations: Setup flow chart, SF-3 front and rear, low-pass/high-pass SIP selection chart, SIP identifier chart.

MOUNTING TO AMPLIFIER.....12

APPLICATION EXAMPLE.....13

WARRANTY INFORMATION.....14

HOW TO CONTACT QSC AUDIO PRODUCTS15

INTRODUCTION & DESCRIPTION OF EACH MODEL

Introduction

This manual covers setup and operation of cinema crossover accessories for QSC DCA Digital Cinema Amplifiers. There are three models: the XC-3 crossover, the LF-3 low frequency filter, and the SF-3 subwoofer filter. Together with DCA amplifiers, they allow you to assemble any type of cinema sound system, mono or multi-channel.

Each accessory mounts directly to the back of the amplifier by plugging into the amplifier's DataPort and is secured with three screws. Operating power and all connections between the accessory and amplifier are provided by the DataPort connection.

Frequency and delay parameters are user-adjustable by inserting selected 8-pin SIP resistor networks into sockets on the underside of the accessory. A DIP switch permits selection of functions such as delay and high-frequency boost, depending upon model. Each accessory includes an assortment of the proper SIP resistor networks and three mounting screws. Keep the unused SIPs for future use.

Description of each model

XC-3 This accessory is a two-way crossover, with the low frequency band fed to channel 1 of the amplifier and the high frequencies to channel 2. An all-pass filter on the low frequency band delays the audio signal, permitting time alignment of a cone driver with a high-frequency horn. A selectable high-frequency boost circuit provides several increments of compensation for screen loss or constant-directivity horn equalization. A HF trim control provides 0 to 20 dB of attenuation for matching levels between frequency bands.

The XC-3 can be used by itself with one amplifier for a 2-way system (shown opposite page, bottom-left), or with the LF-3 and an additional amplifier for 3-way systems, as shown, opposite page, bottom-right. The XC-3 has a pass-through output in parallel with the input for distributing the audio signal to the LF-3. The filter circuitry uses a 4th-order Linkwitz-Riley alignment with 24 dB/octave slopes.

LF-3 Used in a system with the XC-3, the LF-3 performs the low-frequency crossover functions in a 3-way system as shown, opposite page, bottom-right. Unlike the XC-3, it has two discrete channels; one LF-3 with an amplifier will support two other amplifiers with two XC-3 accessories, as shown. The 4th-order Linkwitz-Riley low-pass filters have 24 dB/octave slopes.

Each channel has an all-pass filter providing delay for time alignment. Frequency and delay parameters for both channels are set individually, although typically they would be set the same.

Each channel has a trim control that provides 0 to 20 dB of attenuation for matching levels among the various frequency bands.

SF-3 The SF-3 Subwoofer Filter has two summed inputs and a bandpass filter that defines the frequency range of the subwoofer program. The frequencies of the 2nd-order high-pass and 4th-order Linkwitz-Riley low-pass filters are both set by the user by selecting and installing the appropriate SIP networks. The high-pass filter also has a switchable low-frequency boost feature: switched on, it provides a 6 dB bump at the selected high-pass frequency, useful for extending the low-end response of some speaker systems; off, the response is a flat Butterworth curve that is 3 dB down at the selected frequency. The output is parallel, feeding the same signal into both channels of the amplifier. The SF-3 has no delay function. A level trim control provides 0 to 20 dB of attenuation.

The SF-3 can be used to derive subwoofer-range program from full-range audio, as shown, opposite page, bottom-left. It can also be used with a discrete subwoofer channel in cinema sound systems.

CONFIGURING THE ACCESSORIES

Configuring the Accessories

Configure each accessory before you mount it to the amplifier. If an accessory is already mounted to an amplifier, always turn the amplifier off before changing switch settings, changing input or output connections, or detaching the accessory.

Use the tables on the following pages to determine the correct SIP resistor network value for the desired frequency and delay settings. SIP identification charts are included to help you identify the values of the resistor networks. A flowchart for each model will help you properly configure the accessory.



NOTE: Even if you don't use a particular filter or delay feature on an accessory, put an unused SIP resistor network of any value into its socket to ensure circuit stability when it is powered up.

The SIP resistor networks have no polarity and therefore do not need to be inserted in a certain direction. Make sure all eight pins are inserted properly into the socket holes, and then gently but firmly press the network into the socket until it is fully seated. If a SIP resistor network is difficult to remove with your fingers, use a small screwdriver, prying gently first at one end of the SIP and then the other, until it is loose.

Configurable functions of the three accessory models

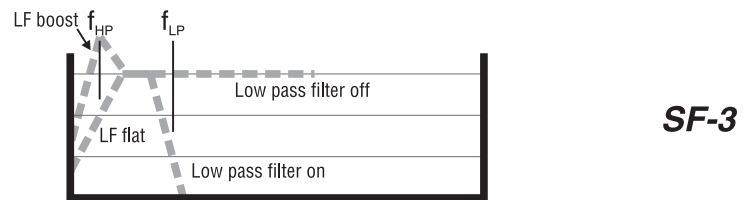
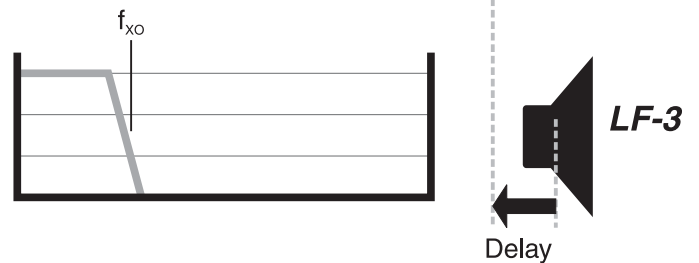
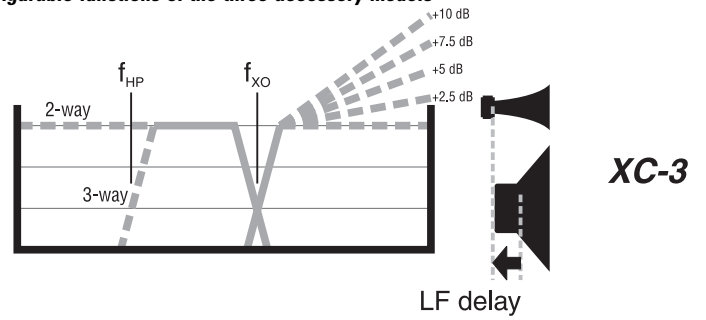

Using the XC-3 in a simple two-way system. In many speaker systems, a passive mid/high combination will handle the higher frequencies, creating essentially a three-way system.

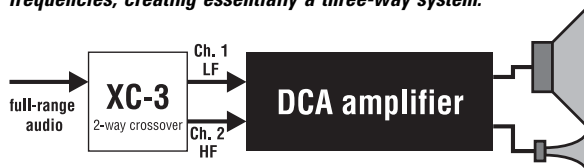

Using the SF-3 with a discrete subwoofer channel

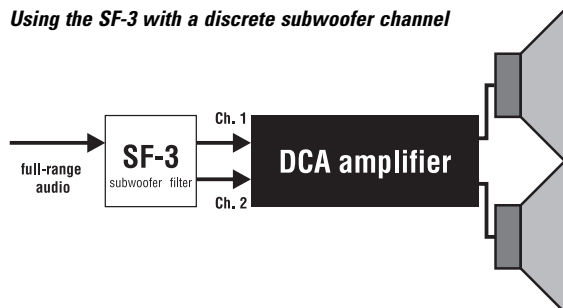

Using the XC-3 and LF-3 in a stereo three-way system

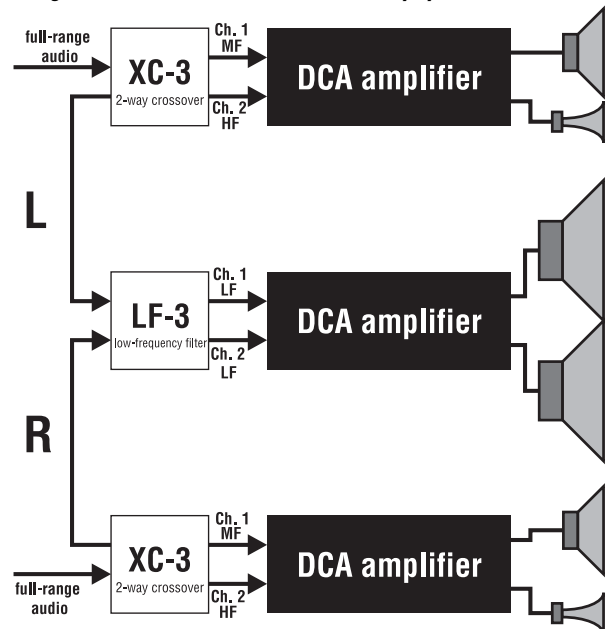

XC-3

Setting up the XC-3

Setting up the XC-3

Setting up the XC-3 requires setting the DIP switches and selecting/inserting SIP resistors into the appropriate sockets. DIP switches #2, #9, and #10 must be set to the ON position (default settings for the XC-3). The flowchart below takes you through all the steps necessary before mounting the accessory to the amp.

The illustration below shows the locations of the sockets for the SIP resistor networks. The SIP resistor networks can be inserted either way, as long as each network pin goes into its own hole in the socket. Straighten the pins, if needed, before inserting the SIP into its receptacle.

Use the tables on the following page to select the correct resistor networks for the settings you need. The SIPs supplied with the XC-3 provide a selectable frequency range for f_{XO} of 80 Hz to 1.5 kHz, and delay settings from 0.3 to 1.8 milliseconds; contact QSC's Technical Services Group if your application requires different settings.

When using the XC-3 in a three-way system in conjunction with the LF-3, the lower frequency (f_{HP}) should match the crossover frequency of the LF-3 (f_{XO}). The SIPs supplied with the XC-3 allow a selectable frequency range for f_{HP} of 80 to 500 Hz.

Setup flowchart for the XC-3

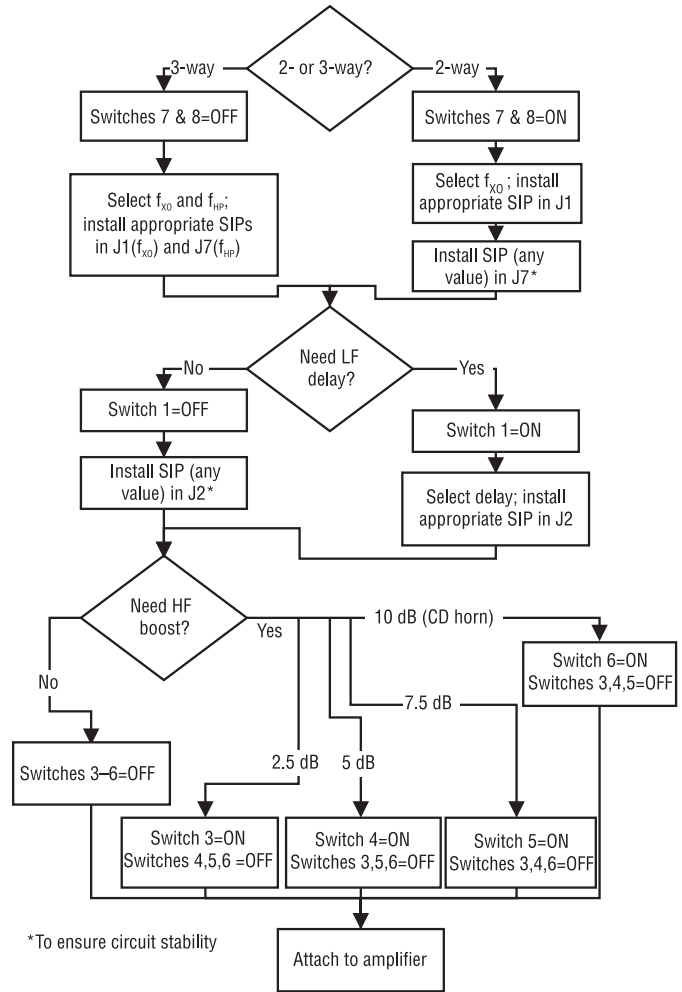

XC-3 Factory-installed SIPs

f_{XO}	500 Hz (12 k Ω SIP resistor in J1)
LF delay	1.8 milliseconds (27 k Ω SIP resistor in J2)
f_{HP}	80 Hz (68 k Ω SIP resistor in J7)

XC-3 controls, switches, and SIP socket locations

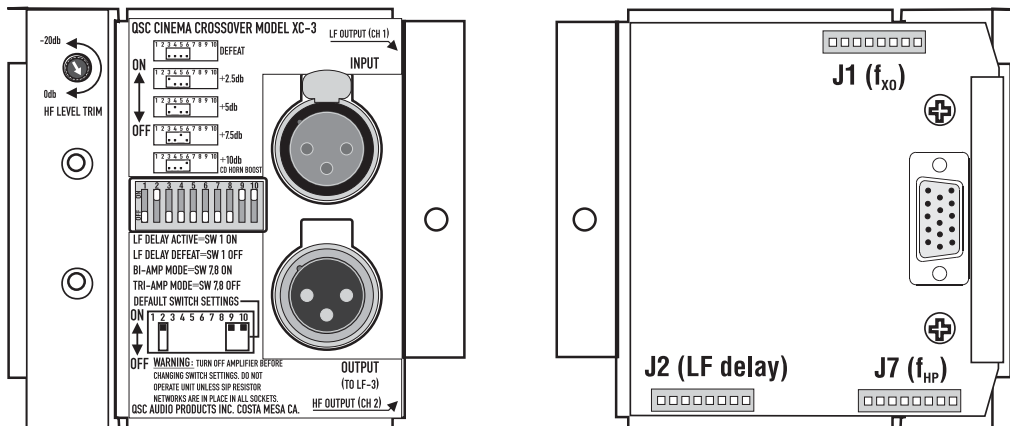

XC-3

Setting up the XC-3

XC-3 Factory Switch Settings

When shipped from the factory, the DIP switch settings should be set as follows:

- Switches 7 & 8 ON: sets XC-3 to Biamp mode
- Switch 1 ON: activates LF delay
- Switches 3 through 6 OFF: HF boost disabled
- Switches 2, 9, and 10 ON: Factory default settings for proper operation.

XC-3 Recommended Amplifier Settings

Clip limiters: ON (both channels)

Low frequency filters: ON (both channels), select either 30 or 50 Hz roll-off, depending on speaker specifications (both channels)

Operating mode: stereo

Use these tables to determine the correct resistor values for the crossover frequencies and delays you need. The shaded values are for the high-pass frequency (f_{hp}) of the XC-3.

Delay (ms)	SIP resistor value
1.8	27K
1.4	22K
1.3	20K
1.2	18K
1	15K
0.8	12K
0.7	10K
0.6	8.2K
0.5	6.8K
0.4	5.6K
0.3	4.7K

Crossover freq. (f_{x0})	SIP resistor value
80 Hz	68K
150 Hz	39K
200 Hz	27K
250 Hz	22K
300 Hz	20K
350 Hz	18K
400 Hz	15K
500 Hz	12K
600 Hz	10K
650 Hz	8.2K
800 Hz	6.8K
1 kHz	5.6K
1.2 kHz	4.7K
1.5 kHz	3.9K

Identifying SIP resistor networks



Use only these three digits to determine resistance code. Disregard the other numerals and letters.

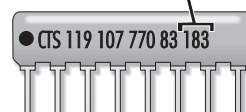
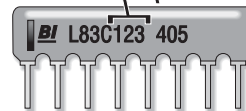

RESISTANCE (ohms)	CODE
2.7K	272
3.9K	392
4.7K	472
5.6K	562
6.8K	682
8.2K	822
10K	103
12K	123
15K	153
18K	183
20K	203
22K	223
27K	273
33K	333
39K	393
47K	473
56K	563
68K	683

Effects of high frequency boost on frequency response (crossover frequency = 500 Hz). A boost of +10 dB is most common for compensating for screen loss (attenuation of high frequencies as sound passes through screen perforations).

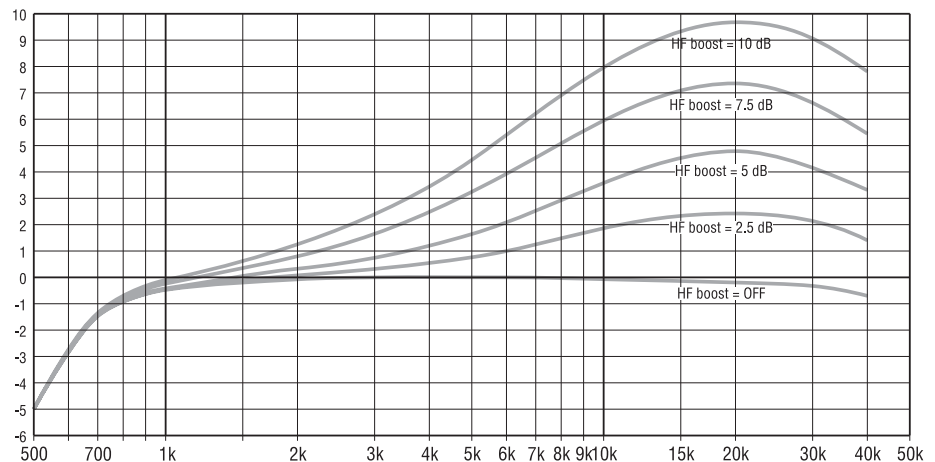

Setting up the LF-3

Setting up the LF-3 requires setting the DIP switches and selecting/inserting SIP resistors into the appropriate sockets. DIP switches #2 and #4 through #9 must be set to OFF, and switch #3 set to ON (factory default for proper operation). The flowchart, right, takes you through the steps necessary before mounting the accessory to the amp.

The LF-3 is typically used in a system in conjunction with the XC-3 crossover. For example, a stereo three-way system will require three DCA amplifiers, two XC-3's, and one LF-3. The typical input signal is full-range audio taken from the XC-3's male XLR connector labeled "OUTPUT (TO LF-3)".

The illustration, below, shows the locations of the sockets for the SIP resistor networks. The resistor networks can be inserted either way, as long as each pin goes into its own receptacle. Straighten pins, if needed, before inserting the SIP into its receptacle.

Use the tables on the following page to select the correct resistor networks for the crossover frequency (f_{x0}) and delay settings you need. The SIPs supplied with the LF-3 provide a range of frequency selections from 80 Hz to 500 Hz, and delay settings from 0.3 to 1.8 milliseconds; delay can be bypassed by putting Switches 1 and 10 in the OFF position. Contact QSC's Technical Services Group if your application requires different settings.

When using the LF-3 in a three-way system in conjunction with the XC-3, the crossover frequency of the LF-3 (f_{x0}) should match the lower high-pass frequency (f_{HP}) of the XC-3.

In most circumstances, the LF-3 would be used with an amplifier in stereo mode. But if two amp channels are needed for one low frequency signal, you can use the Input 1 connector of the LF-3 and parallel the inputs of the amplifier. Amplifier inputs can be paralleled using the amplifier's DIP switches (mode switches).

Setup flowchart for the LF-3

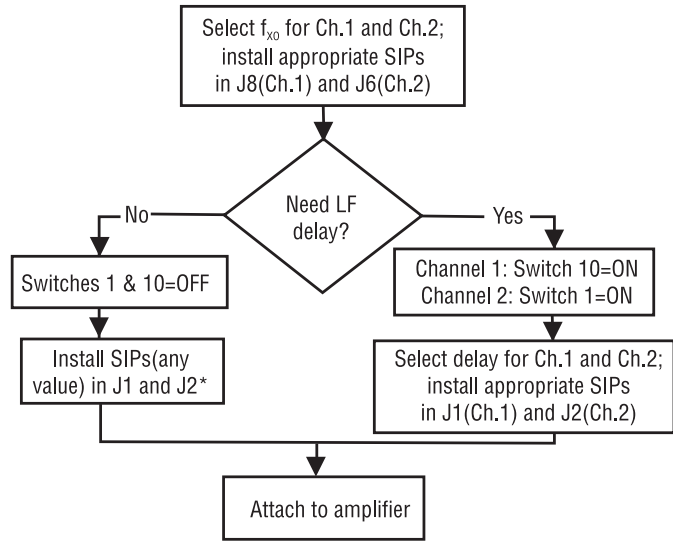

*To ensure circuit stability

LF-3 controls, switches, and SIP socket locations

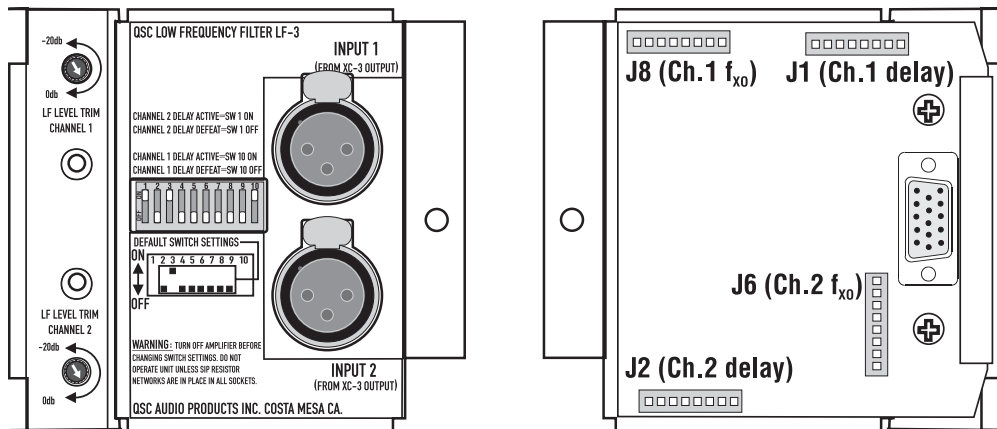

LF-3

Setting Up the LF-3

LF-3 Factory-installed SIPs

- f_{xo} 350 Hz, both channels (18 k Ω SIP resistor installed in J6 and J8)
- Delay 1.4 milliseconds, both channels (22 k Ω SIP resistor installed in J1 and J2)

LF-3 Factory Switch Settings

When shipped from the factory, the DIP switch settings should be set as follows:

- Switch 1 and Switch 10 ON: Delay active (both channels)
- Switch 2 and Switches 4 through 9 OFF: Required default setting for proper operation of the LF-3
- Switch 3 ON: Required default setting for proper operation of the LF-3

LF-3 Recommended Amplifier Settings

- Clip limiters: ON, (both channels)
- Low-frequency filters: ON (both channels), select either 30 or 50 Hertz roll-off depending on speaker specifications (both channels)
- Operating mode: Typically Stereo mode, but Parallel mode can be used in applications requiring dual LF amp channels with one source

Use these tables to determine the correct resistor values for the crossover frequencies and delays you need.

Crossover freq. (f_{xo})	SIP resistor value
80 Hz	68K
150 Hz	39K
200 Hz	27K
250 Hz	22K
300 Hz	20K
350 Hz	18K
400 Hz	15K
500 Hz	12K

Delay (ms)	SIP resistor value
1.8	27K
1.4	22K
1.3	20K
1.2	18K
1	15K
0.8	12K
0.7	10K
0.6	8.2K
0.5	6.8K
0.4	5.6K
0.3	4.7K

Identifying SIP resistor networks



Use only these three digits to determine resistance code. Disregard the other numerals and letters.

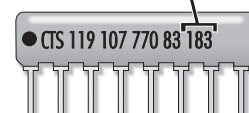
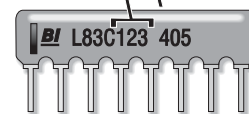

RESISTANCE (ohms)	CODE
2.7K	272
3.9K	392
4.7K	472
5.6K	562
6.8K	682
8.2K	822
10K	103
12K	123
15K	153
18K	183
20K	203
22K	223
27K	273
33K	333
39K	393
47K	473
56K	563
68K	683

SF-3

Setting up the SF-3

Setting up the SF-3

Setting up the SF-3 requires setting the DIP switches, and selecting/inserting SIP resistors into the appropriate sockets. DIP switches #1 through #6 and #10 must be set to OFF (factory default for proper operation). The flowchart, right, takes you through all the steps necessary before mounting the accessory to the amp.

The illustration below shows the locations of the two SIP sockets on the SF-3. The resistor networks can be inserted either way, as long as each pin goes into its own receptacle. Straighten pins, if needed, before inserting the SIP into its receptacle.

The mono subwoofer program can be derived from summing and filtering stereo or mono full-range audio or it can come from a discrete mono subwoofer channel, such as in a 5.1, 6.1, or 7.1 cinema surround system. If the subwoofer program is to be derived, use the SF-3's low-pass filter to set the high end of the subwoofer passband. If the subwoofer program source is a discrete channel, as in most cinema systems, we recommend you bypass the low-pass filter.

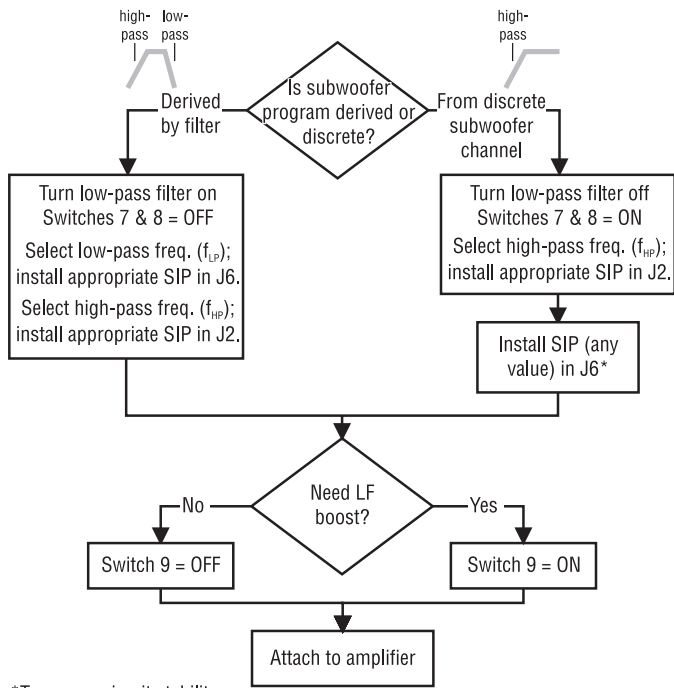

*To ensure circuit stability

Use the table, opposite page, to select the correct resistor networks for the SF-3's filter frequency settings. The SIPs supplied provide a selection of three low-pass frequencies: 80, 150, and 250 Hz; and six high-pass frequencies from 20 to 50 Hz. Use the speaker manufacturer's recommended filter settings.

The low-frequency boost switch selects the Q of the high-pass filter: 0.707 for flat (Butterworth), or 2 for "boost," which adds a 6 dB peak at the filter's selected frequency.

SF-3 controls, switches, and SIP socket locations

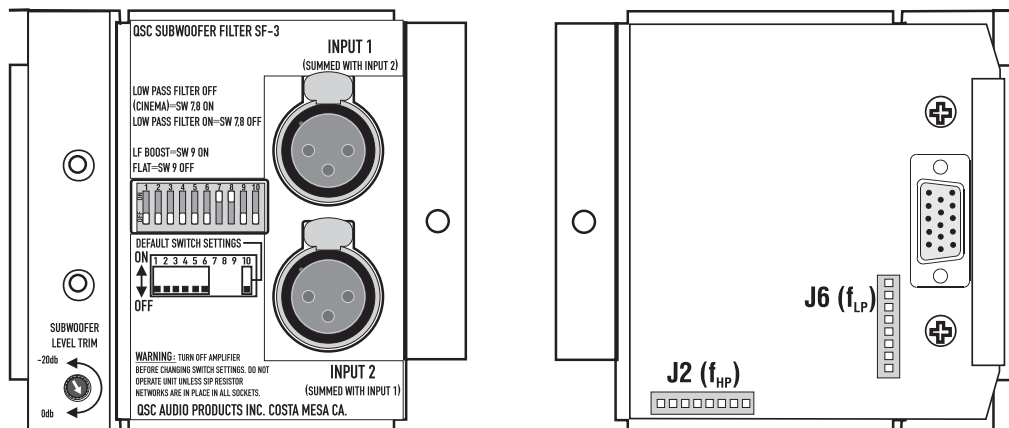

SF-3

Setting Up the SF-3

SF-3 Factory-installed SIPs

fHP= 30 Hz (27 kΩ SIP resistor in J2)

fLP= 250 Hz (22 kΩ SIP resistor in J6)

SF-3 Factory Switch Settings

When shipped from the factory, the DIP switch settings should be set as follows:

Switches 1 through 6 and Switch 10 OFF: Default setting for SF-3

Switches 7 & 8 ON: Low-pass filter off ("cinema" setting)

Switch 9 OFF: LF flat

SF-3 Recommended Amplifier Settings

Clip limiters ON (both channels)

High-pass filter OFF (both channels)

Operating mode: Stereo or Bridge mode, as the application requires

Use this table to determine the correct resistor values for the SF-3 filter frequencies.

Low-pass freq. (f _{LP})	SIP resistor value
80 Hz	68K
150 Hz	39K
250 Hz	22K
High-pass freq. (f _{HP})	SIP resistor value
20 Hz	47K
25 Hz	33K
30 Hz	27K
35 Hz	20K
40 Hz	15K
50 Hz	10K

Identifying SIP resistor networks

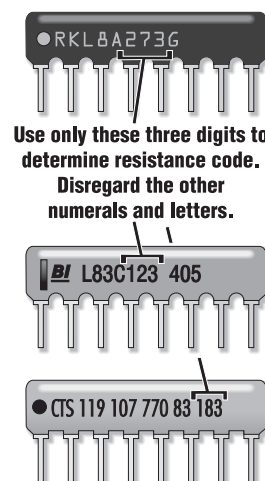

RESISTANCE (ohms)	CODE
2.7K	272
3.9K	392
4.7K	472
5.6K	562
6.8K	682
8.2K	822
10K	103
12K	123
15K	153
18K	183
20K	203
22K	223
27K	273
33K	333
39K	393
47K	473
56K	563
68K	683

MOUNTING- All Models

Mounting the Accessories

An accessory may be mounted with the amplifier either in or out of the rack, even if the amp is installed with rear rack ears.

1. Turn off the amplifier before installing the accessory.
2. Make sure the SIP resistor networks are installed properly and no SIP sockets are empty.
3. Line up the HD-15 connector on the accessory with the amplifier's DataPort, then press the accessory onto the back of the amplifier so that the HD-15 connector inserts into the DataPort.
4. Use the three screws supplied to secure the accessory to the amplifier chassis, as shown below. Two long screws go into the holes near the DataPort, while the short screw goes through the hole in the tab on the right edge of the accessory. Do not overtighten the screws.
5. Attach the input and output cables to the appropriate connectors on the accessory. Use the amplifier's normal output connectors for attaching speaker and monitor cabling.

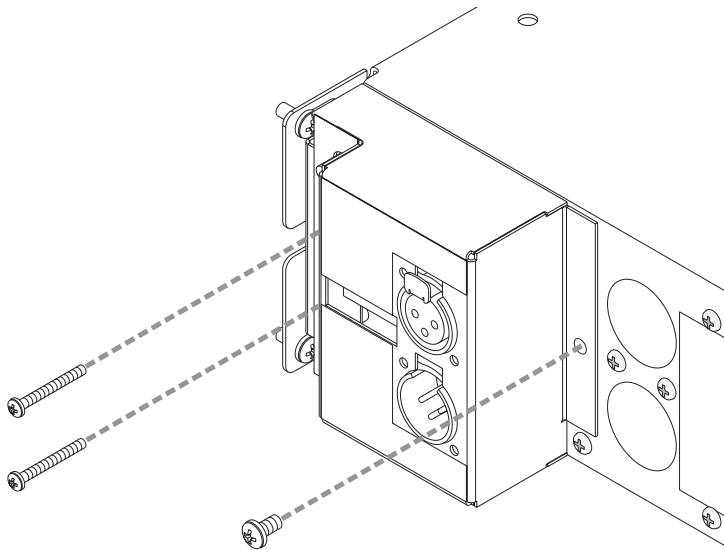

APPLICATION EXAMPLE- Setting Up in the Cinema Sound System

Setting up the DCA Accessories in the Cinema Sound System

Setting up the DCA accessories in the B chain of the cinema sound system primarily involves setting the trim levels on the XC-3, LF-3, and SF-3. This requires the cinema processor's internal pink noise generator and an acoustical real-time spectrum analyzer.

1. Set up the analyzer microphone in the center of the cinema audience seating area or in another recommended location.
2. Set the all DCA amplifiers' gain controls to maximum.
3. Route the pink noise test signal from the cinema processor to the left channel XC-3 input. Observe the frequency response on the spectrum analyzer and use the HF trim control on the XC-3 and the LF trim on the LF-3 to balance the levels of their frequency bands to that of the mid-frequency band, within specifications. If the shape of the HF response is not correct, use a boost setting that better corrects the deficiency; turn the amplifiers off before changing the switch settings.
4. Repeat this process for the center and right screen channels and any surround channels that are bi- or tri-amped.
5. Follow the processor instructions for setting sound pressure level outputs of all the channels, including the subwoofer.

If you are unable to obtain a satisfactory frequency response or SPL on a channel, carefully check the wiring and connections. Some likely causes are reversed speaker polarity on one or more drivers, loose or broken wiring or connections, or blown or damaged speaker drivers.

A typical 6.1 surround system with DCA amplifiers and LF-3, SF-3, and XF-3 cinema accessories

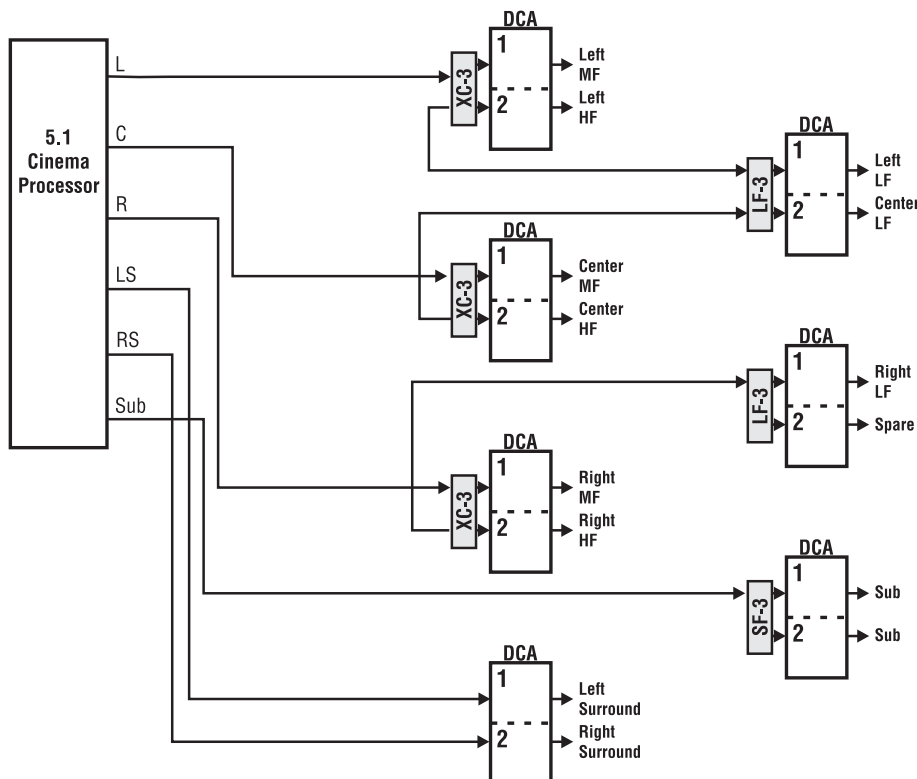

MAINTENANCE AND WARRANTY

Cleaning

The faceplate and chassis can be cleaned with a soft cloth and nonabrasive, noncorrosive, mild cleaning solution. Products like Simple Green and Windex work well. Do not use powders or scrubbing pads of any type as they are usually abrasive and will permanently damage the finish of your cinema accessory. Dampen a soft, lint-free cloth with the cleaning solution and wipe the accessory gently. Ensure that cleaning solution does not get down into the connectors. Do not spray the solution directly onto the accessory as it will penetrate into the connectors.

User Maintenance

There is no user-level maintenance on the LF-3, SF-3, or XF-3. Contact QSC's Technical Services Group if service is required.

Warranty Information

If the cinema accessory isn't working properly, please verify the accessory's DataPort connector is properly seated on the amplifier and that all retaining screws are tight. If proper operation can not be restored, the accessory may require service. This must be performed by qualified service personnel. To obtain the location of your nearest QSC Authorized Service Center, please contact your QSC dealer or contact QSC's Technical Services Group.

Disclaimer

QSC Audio Products, Inc. is not liable for any damage to speakers, amplifiers, or any other equipment that is caused by negligence or improper installation and/or use of the LF-3, SF-3, or XF-3. Due to the possibility of the user installing a SIP resistor improperly or of an incorrect value, QSC Audio Products, Inc. is not liable for any direct or indirect damage caused by improper SIP installation or value selection.

one sent to you. This warranty does not cover shipping damage caused by improper packing or the use of improper shipping cartons.

QSC Audio Products 3 Year Limited Warranty

QSC Audio Products, Inc. ("QSC") guarantees its products to be free from defective material and / or workmanship for a period of three (3) years from date of sale, and will replace defective parts and repair malfunctioning products under this warranty when the defect occurs under normal installation and use - provided the unit is returned to our factory or one of our authorized service stations via pre-paid transportation with a copy of proof of purchase (i.e., sales receipt). This warranty provides that the examination of the return product must indicate, in our judgment, a manufacturing defect. This warranty does not extend to any product which has been subjected to misuse, neglect, accident, improper installation, or where the date code has been removed or defaced. QSC shall not be liable for incidental and/or consequential damages. This warranty gives you specific legal rights. This limited warranty is freely transferable during the term of the warranty period.

Customer may have additional rights, which vary from state to state.

In the event that this product was manufactured for export and sale outside of the United States or its territories, then this limited warranty shall not apply. Removal of the serial number on this product, or purchase of this product from an unauthorized dealer, will void this limited warranty.

Periodically, this warranty is updated. To obtain the most recent version of QSC's warranty statement, please visit www.qscaudio.com.

Contact us at 800-854-4079 or visit our website at www.qscaudio.com.

HOW TO CONTACT QSC



WORLD WIDE WEB:

<http://www.qscaudio.com>



TELEPHONE NUMBERS:

Main Number +1 (714) 754-6175

Sales Direct Line +1 (714) 957-7100
or (800) 854-4079 toll free (U.S.A. only)

Technical Services (714) 957-7150
or (800) 772-2834 toll free (U.S.A. only)



FACSIMILE (FAX) NUMBERS:

Sales & Marketing FAX +1 (714) 754-6174

Technical Services FAX +1 (714) 754-6173



ADDRESS:

QSC Audio Products, Inc.

1675 MacArthur Boulevard

Costa Mesa, CA 92626-1468 USA



© Copyright 1998, 2002 QSC Audio Products, Inc. All rights reserved.

"QSC" and the QSC logo are registered with the U.S. Patent and Trademark Office.

QSC Audio Products, Inc., 1675 MacArthur Boulevard Costa Mesa, California 92626 USA
PH: (714) 754-6175 FAX: (714) 754-6174